

Tap-off shown with non-specific length of conduit for illustration purposes. Tap-off supplied with either 3m or 5m conduit.

### Tap-off types

Ensure the colour of the tap-offs are correct for the type to be fitted to the powertrack prior to installation.

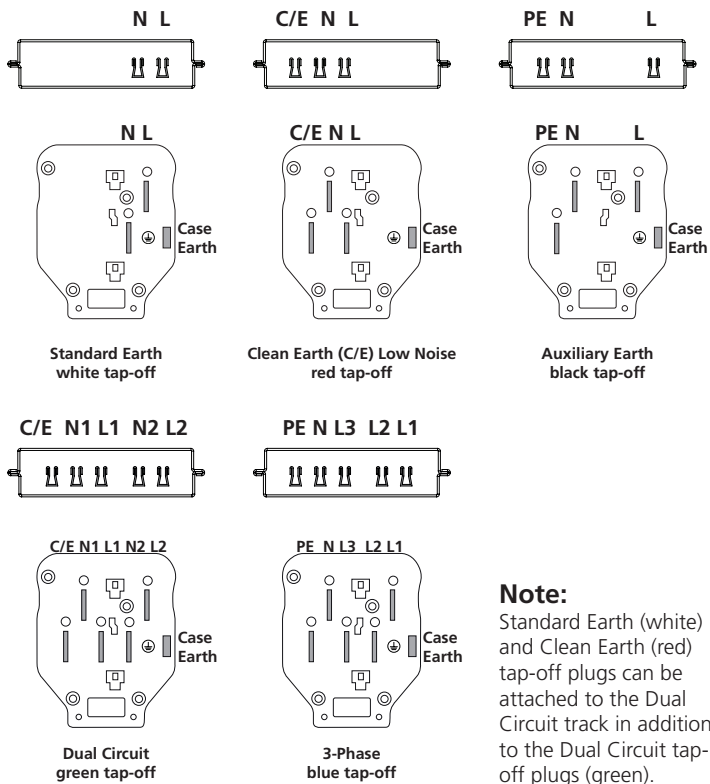

### Conduit/cable lengths

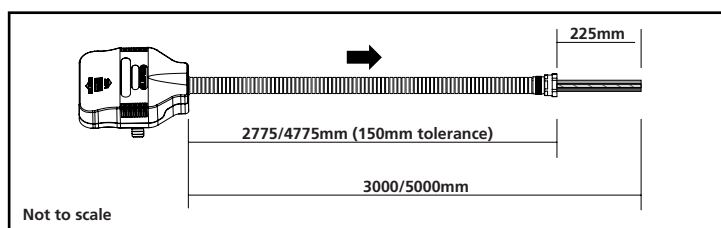

CMD tap-offs are supplied as standard with the metallic conduit being approximately 225mm shorter than the internal cables. A 3m tap-off will be 2775mm long fitted with 3000mm supply cores/internal cables. A 5m tap-off will be 4775mm long fitted with 5000mm supply cores/internal cables.

### Core identification

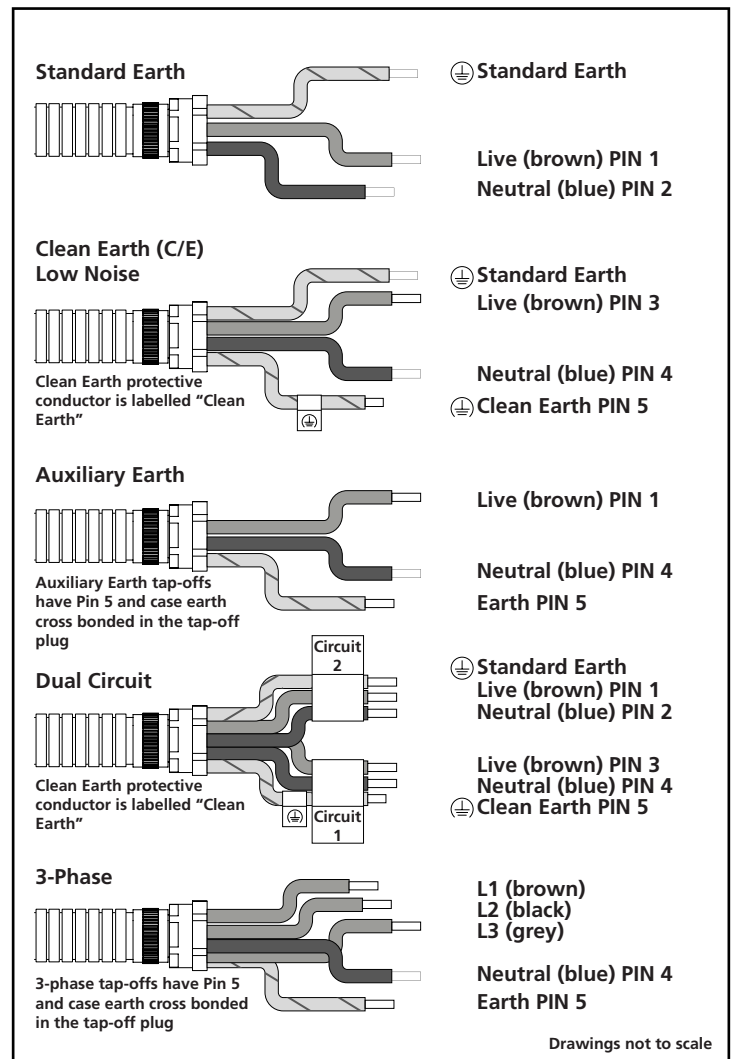

### Conduit/cable preparation

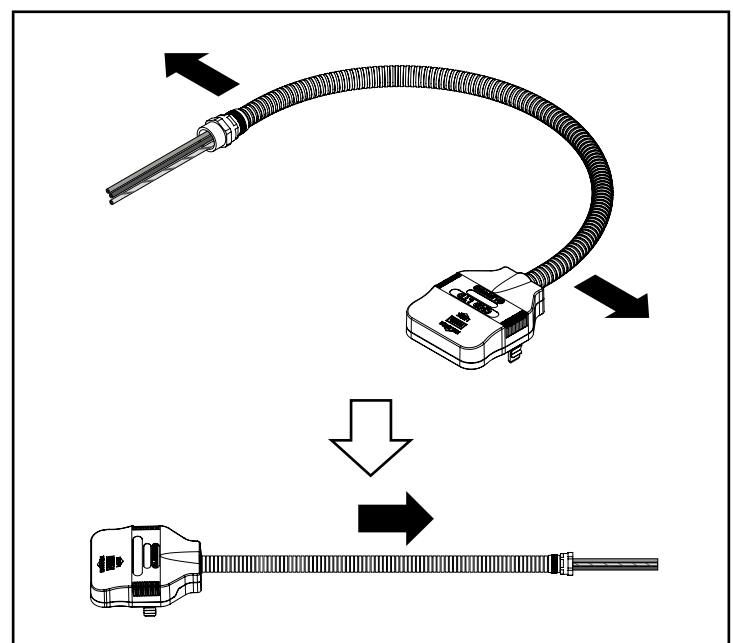

Prior to termination of the tap-off, the conduit must be stretched to its full length to ensure the terminations at the load side are not stressed, as the cables are supplied 225mm longer than the tap-off. Failure to do this could cause undue pressure to all cable terminations.

## Connecting and earthing the conduit

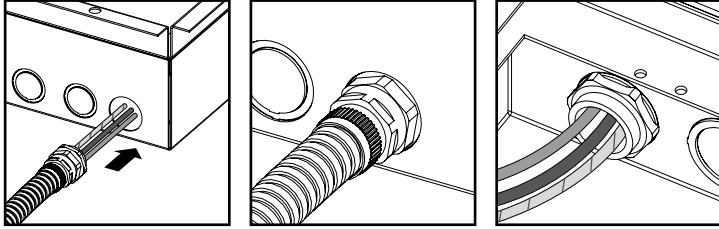

All tap-off flexible metallic conduits must be connected to earth via the exposed-conductive-part of the metalwork. The nut of the gland should make contact with the exposed earthed metalwork as shown.

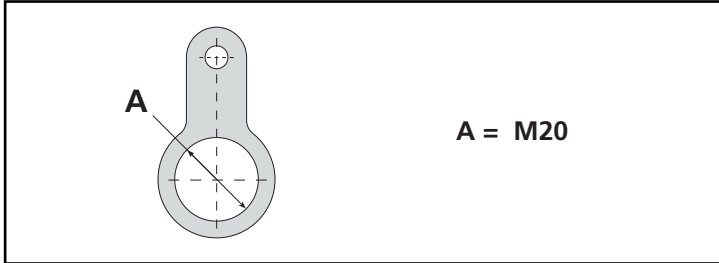

If the tap-off is being fitted to a non-conductive part at the load side (e.g a plastic mounting box) a 20mm earthing ring (Banjo) must be utilised and connected to the CPC.

## Tap-off engagement/release

**\*\*WARNING\*\***  
An unterminated tap-off **MUST NEVER** be connected to a live track. Provided that it is off load, a terminated tap-off may be removed/inserted into a live track. Conduit must be bonded to Earth.

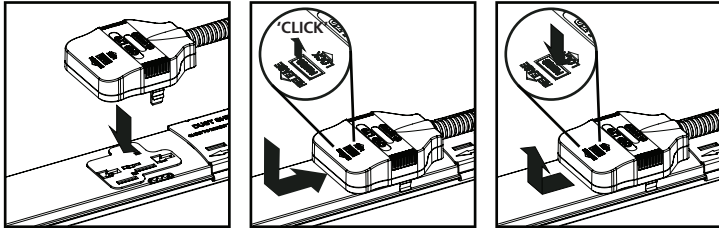

Align tap-off pins with slots on socket. Push down to engage.

Press down and push backwards until button clicks upwards to lock.

To remove, press button to disengage. Push forwards and lift up to remove.

## Changing the fuse in a Tap-off plug (if applicable)

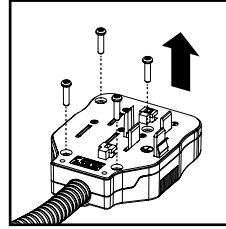

Remove 4x screws from bottom face of tap-off plug casing as shown and keep to one side.

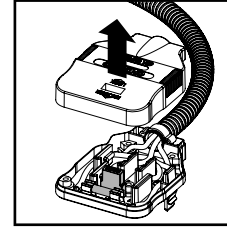

Separate the plug casing to reveal the internal components and the fuse.

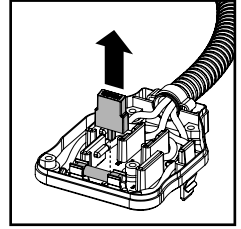

Ensure the green release button is not mislaid when removing the casing. Keep it safe.

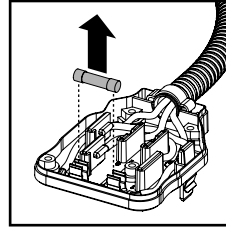

Carefully lift out the fuse from its holder. Use a suitable tool if necessary.

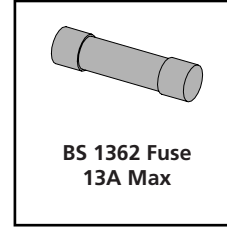

Replace with a BS 1362 fuse with a maximum rating of 13A.

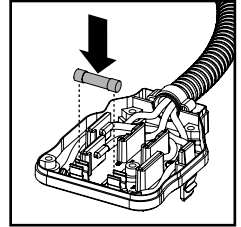

Insert the new fuse and check all connections are in good condition and the fuse fits tightly.

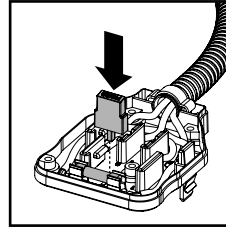

Ensure the green release button is fitted correctly in place before refitting the plug casing.

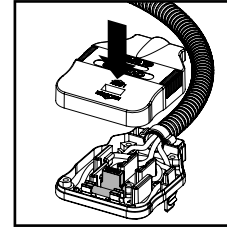

Reassemble the plug casing ensuring all other components are in the correct place.

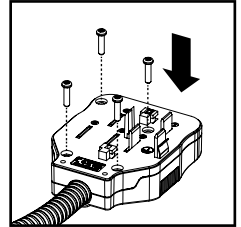

Hold the casing together and secure in place with the 4x screws removed in the first step.

## Additional information

### Safety

- Installation is to be carried out in accordance with relevant Health & Safety regulations and only to be carried out by a skilled or competent person.
- The product should be installed to comply with the relevant national standards and be inspected and tested prior to being put into service (in the UK BS 7671 Wiring Regulations).
- Isolate the supply before installation or repositioning. Any locking mechanisms must be used and fully engaged.
- Incorrect use could lead to risk of electrocution.
- Product to be used only for the intended purpose of distributing power in a commercial environment.
- Do not misuse, dismantle or re-configure the product because doing so will invalidate the warranty.
- To comply with BS 7671 Wiring Regulation 522.06.202 and 522.6.203, a flexible metallic conduit/tap-off installed in a wall or partition at a depth of <50mm, or in a wall with internal construction of which includes metallic parts will require RCD protection upstream.
- If a product incorporates RCD protection, the RCD should be regularly tested in-line with current standards.

### Standards

- Refer to the Declaration of Conformity.

### Product care

- Clean using a dry cloth. No abrasives or solvents to be used on the product.
- Do not drop or expose to moisture.

