

20 series floor box (single box base)

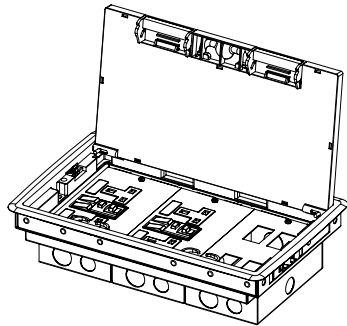

20A series floor box (separate box bases)

****WARNING****
Sharp floor fixing barbs on the lid trim. Be careful when handling.

Prepare the floor area

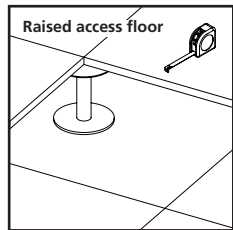

Check there is sufficient clearance under the floor to accept the box and cables.

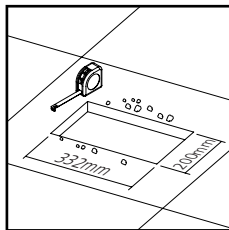

Measure, mark and cut the aperture in the floor. 200 x 332mm -0/+1mm tolerance.

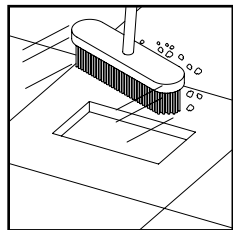

Clear away debris from the aperture to allow proper installation of the floor box.

Lid operation

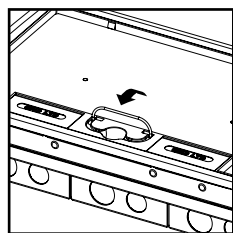

Lift up the wire handle in the centre of the lid.

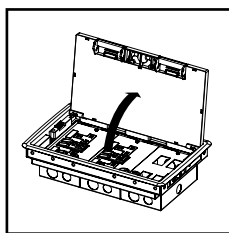

Carefully pull up the lid with the handle and open until it stops as shown.

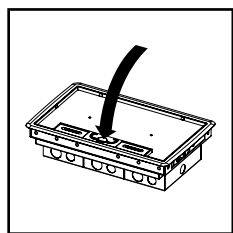

The lid and handle are designed to be self closing for safety. Do not wedge open.

Removing and refitting the lid

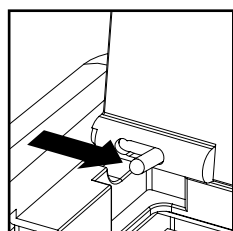

Slide the latches on both ends of the lid towards the centre of the floor box as shown.

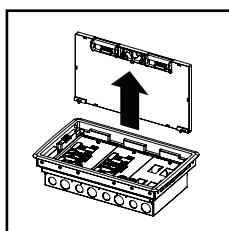

Lift the lid up and away from the floor box..

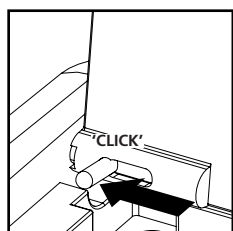

Reverse the previous two steps to replace the lid.

Fast fit installation (applies to both 20 & 20A series)

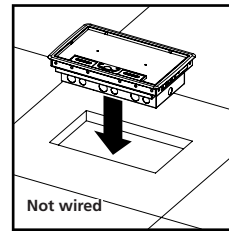

Not wired

Position the floor box centrally over the aperture and lower it down evenly into it.

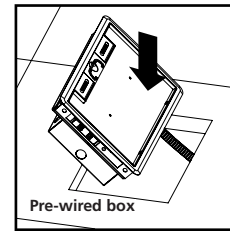

Pre-wired box

Angle the box and lower into the aperture in the floor if the box is pre-wired.

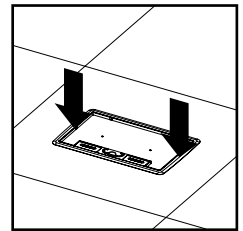

Apply even pressure at both ends of the box at the same time with both hands.

Fast fit installation (applies to 20A series only)

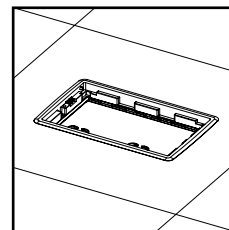

Insert the mounting frame and remove the lid as shown previously to aid installation.

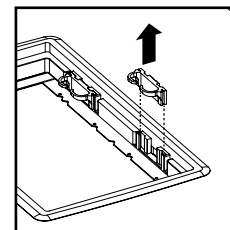

The 2x cable guides may need to be removed to allow the boxes to locate without clashing.

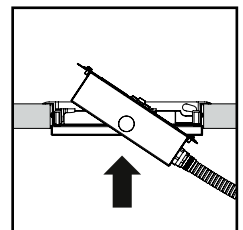

Feed the wired box bases up into the mounting frame from under the floor.

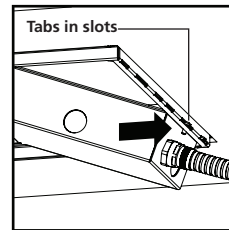

Tabs in slots

The tabs on the box bases point to the lid and feed into slots along the frame edge.

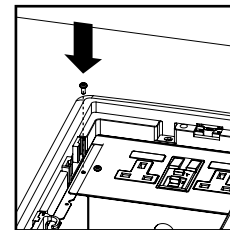

Lower the front end of the box bases onto the frame and fix in place with 1x taptite screw.

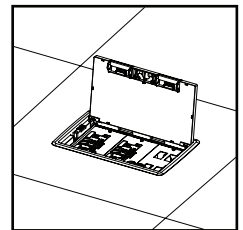

Repeat the process until all box bases are fixed in place. Fit the lid back in place once finished.

Reversible lid (switch the side the lid opens from if necessary)

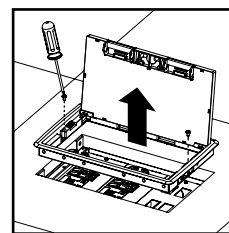

Remove the 2x screws as shown to lift the lid and trim from the floor box.

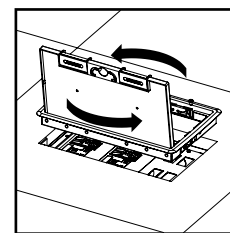

Rotate the lid and trim 180° so the lid will open from the opposite side.

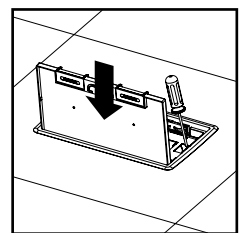

Lower the lid and trim into place and secure with the 2x screws removed in the first step.

Floor box removal (applies to both 20 & 20A series)

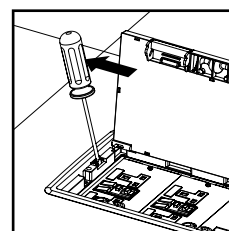

Insert a flat blade screw driver into slot and lever outwards to push metal clip inwards. Hold.

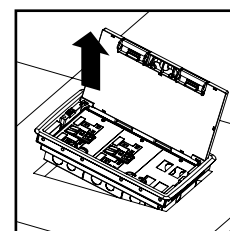

Using the lid as a handle lift up the box at the same end. Be careful of the sharp barbs on sides.

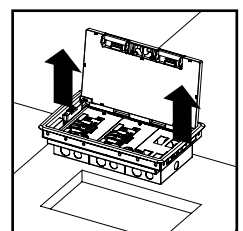

Lift up the box entirely. This process can be done at either end of the floor box.

Earthing the box and sockets

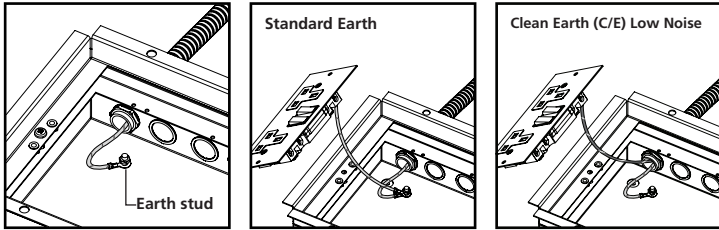

The box base must be earthed with a suitable ring terminal to the integrated earth stud. To ensure the sockets are earthed, a link will be required from the box earth stud to the socket earth. On Clean Earth (C/E) Low Noise installations these should be wired directly to the Clean Earth CPC (Circuit Protective Conductor).

Fitting the lid inlay

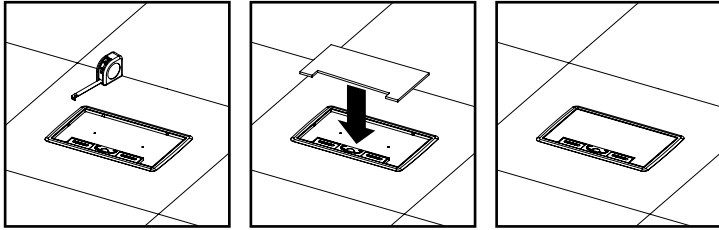

Measure the inside dimensions of the lid.

Carefully cut out the shape from the desired material substrate (carpet, tile etc.)

Fit the inlay into the lid and secure with suitable bonding agent.

Tap-off engagement/release

WARNING

An unterminated tap-off **MUST NEVER** be connected to a live track. Provided that it is off load, a terminated tap-off may be removed/inserted into a live track. Conduit must be bonded to Earth.

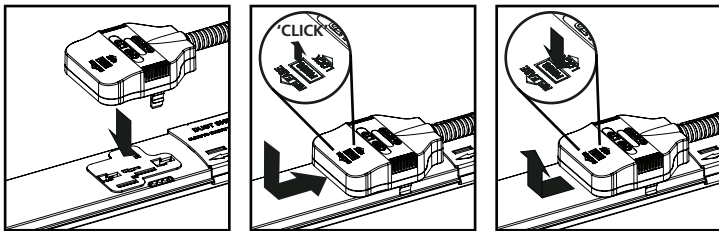

Additional information

Safety

- Installation is to be carried out in accordance with relevant Health & Safety regulations and only to be carried out by a skilled or competent person.
- It is recommended that floor boxes are not installed in high traffic areas.
- The installation should be installed to comply with the relevant national standards and be inspected and tested prior to being put into service (in the UK BS 7671 Wiring Regulations).
- Isolate the supply before installation or repositioning. Any locking mechanisms must be used and fully engaged.
- Incorrect use could lead to risk of electrocution.
- Product to be used only for the intended purpose of distributing power in a commercial environment.
- Do not misuse, dismantle or re-configure the product because doing so will invalidate the warranty.
- If a product incorporates RCD protection, the RCD should be regularly tested in-line with current standards.

Standards

- Refer to the Declaration of Conformity.

Further guidance

- If viewing this sheet prior to specification/technical documentation purposes, be aware of potential plug clashes with certain socket plate orientations.

Product care

- Clean using a dry cloth. No abrasives or solvents to be used on the product. Do not drop or expose to moisture.

Cable management

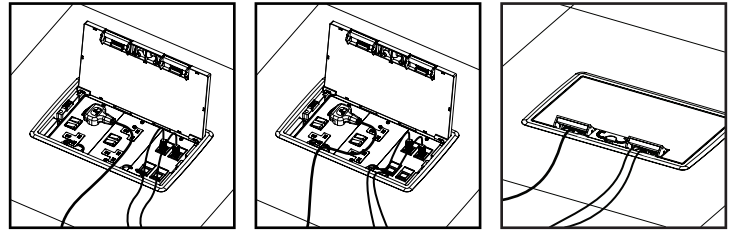

Plug any power and data cables into their respective sockets.

If possible, try to keep power and data cables segregated when using the cable guides.

Carefully close the lid and ensure the cables are fed out through the cable access brackets.

Testing and resetting SRCD socket (if applicable)

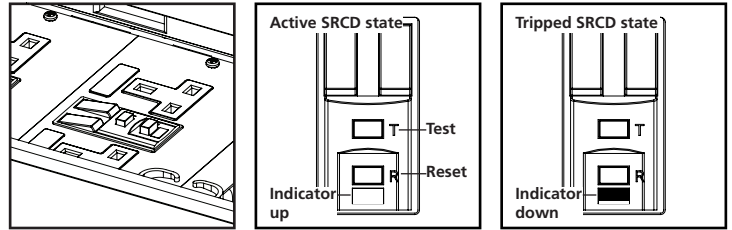

A qualified or fully competent person should test the SRCD before first use.

When active, the SRCD indicator window is filled with a red marker.

When the SRCD trips, the red marker in the indicator window recedes as shown.

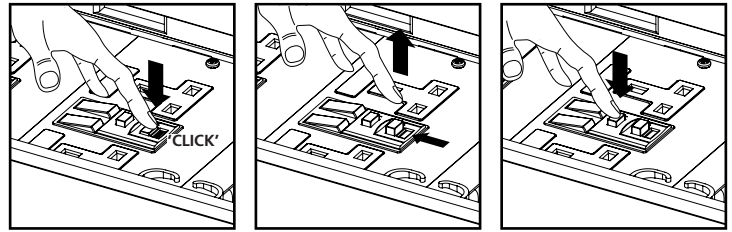

To reset after it has tripped, press and hold the grey reset button until a click is heard.

The indicator will change to show it is now active. Remove your finger from the reset button.

A qualified person should test the SRCD function periodically to comply with standards.

